

KidKase instructions for use in the car

For assistance, please contact The Active Child at (800) 620 - 4959
Downloadable instructions available at www.theactivechild.com

Step 1.

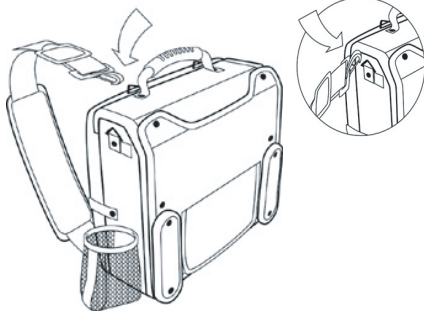

Unhook straps and attach to side of case

Step. 2

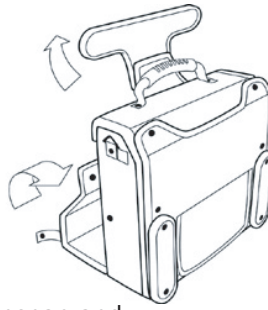

Unsnap and lower back panel

Step.3

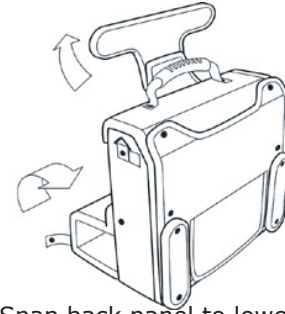

Snap back panel to lower section of case, raise headrest attachment

Step. 4

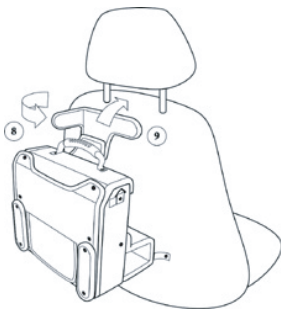

Fold headrest attachment and insert through headrest

Step.5

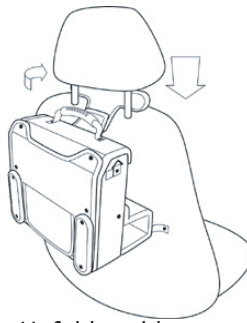

Unfold and lower headrest

Step. 6

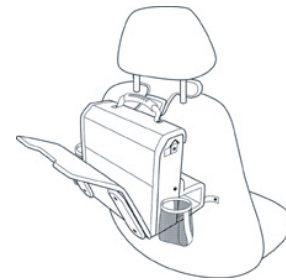

Unsnap and lower outer panel

Step. 7

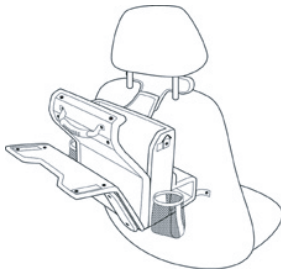

Unsnap and lower tray

Step. 8

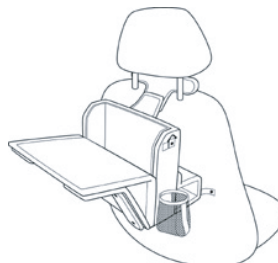

Align and press all 4 snaps firmly.

Step. 9

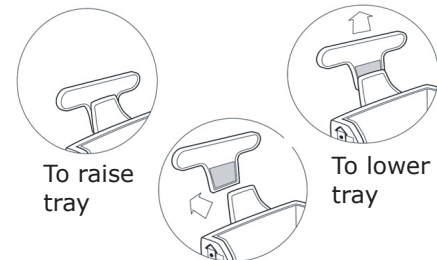

To raise tray

To lower tray

Detach and shorten / lengthen velcro headrest attachment to raise or lower tray

Step. 10

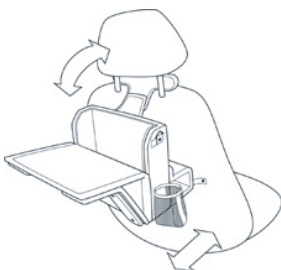

If required, recline seat to lower tray additionally. Slide seat forward for more leg room, slide back to improve reach

Step. 11

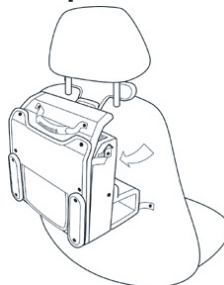

Quick close velcro to hold tray up without fastening any snaps

Step. 12

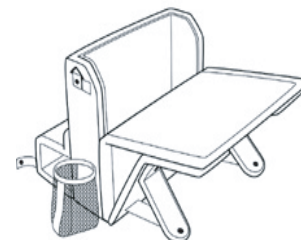

Legs extended for use on a surface

* Note - snaps will "break in" with use and require less force to press together.